

ref. 1903

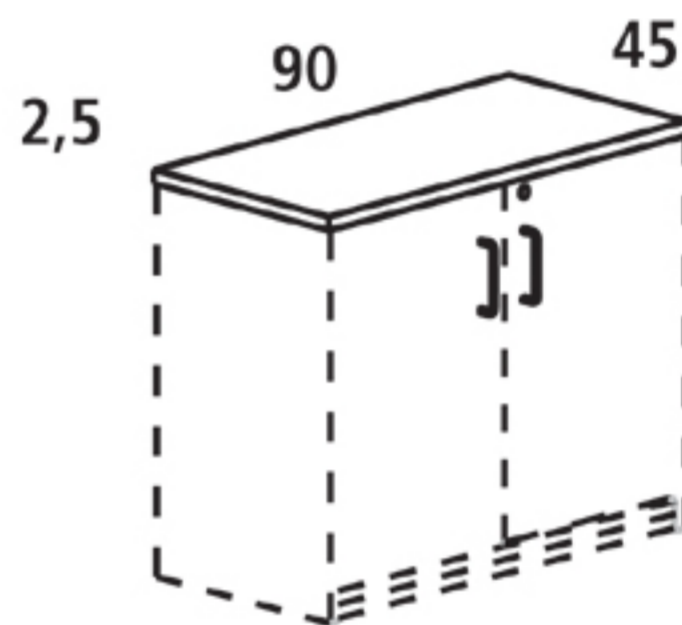

ref. 1904